

ARKÉ fit



Light-weight on
any wall
Connected
in any home





Arké fit.

Beautiful and light-weight on any wall

Arké fit is the **new Vimar cover plate**, the slimmest in the Arké range: sophisticated, with unique finishes. It is light-weight on any wall, providing the perfect flush-fit result, and it blends in seamlessly with any architectural context or interior design style. Furthermore, it guarantees **the perfect styling result, even on plasterboard walls.**

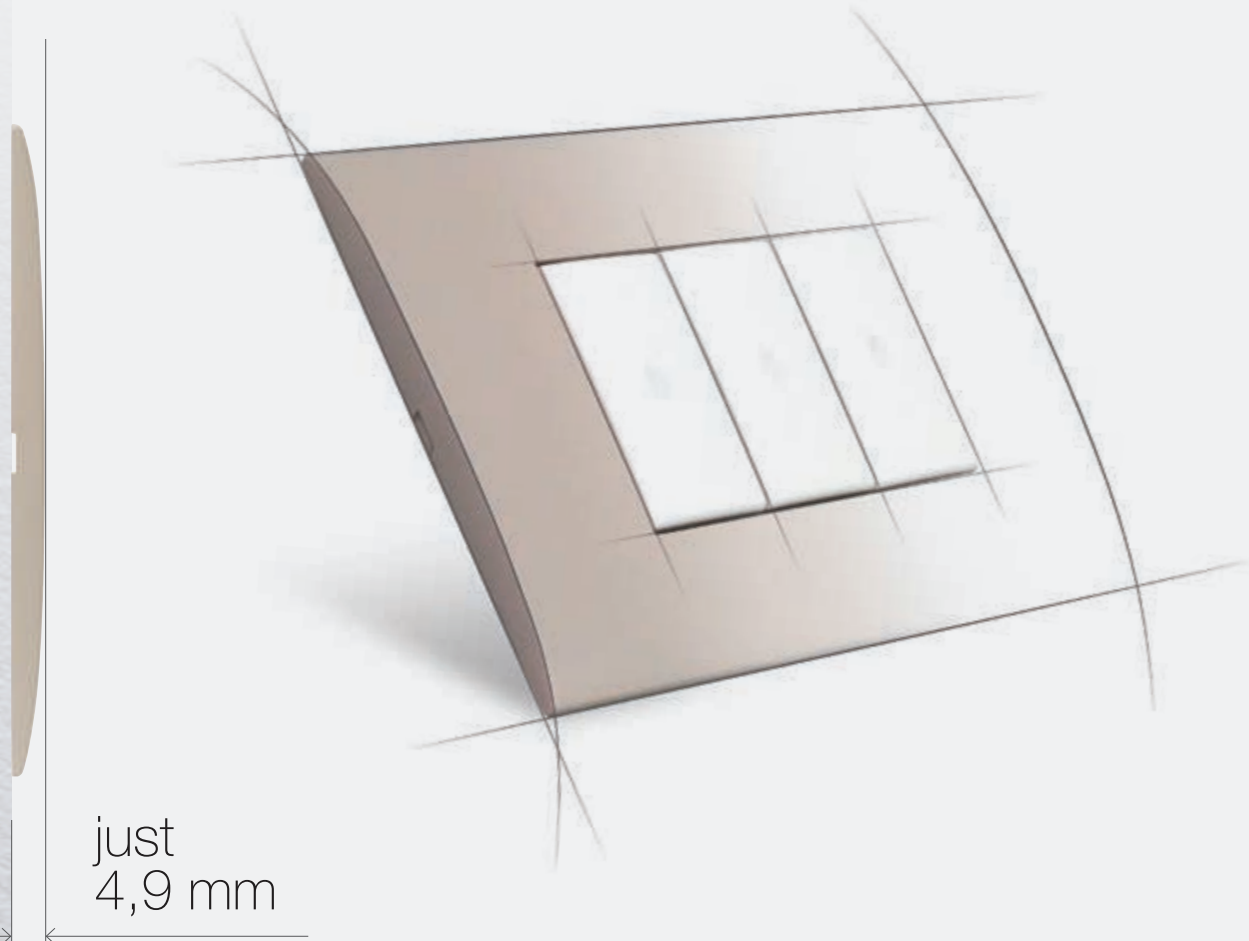

> Slim profile

Protruding by just 4.9 millimetres, the slimmest in the entire wiring series range. A light-weight, imperceptible profile, which with its slim shape enhances the value of its surroundings, accommodating the style of any building.

> Structural solidity

Thanks to the rigidity of the dedicated mounting frame, the solidity of surface mounting both cover plate and device - even on plasterboard walls - is unrivalled, always guaranteeing perfect button alignment. In keeping with the superior quality of Vimar products.

> Even on plasterboard

The special structure of the mounting frame affords an attractive flush-fit effect, where the cover plate blends in seamlessly with the wall. In installations on plasterboard, **it also covers the protrusion of the mounting box perfectly.**

**Lights
scenario off
raise roller
shutters**

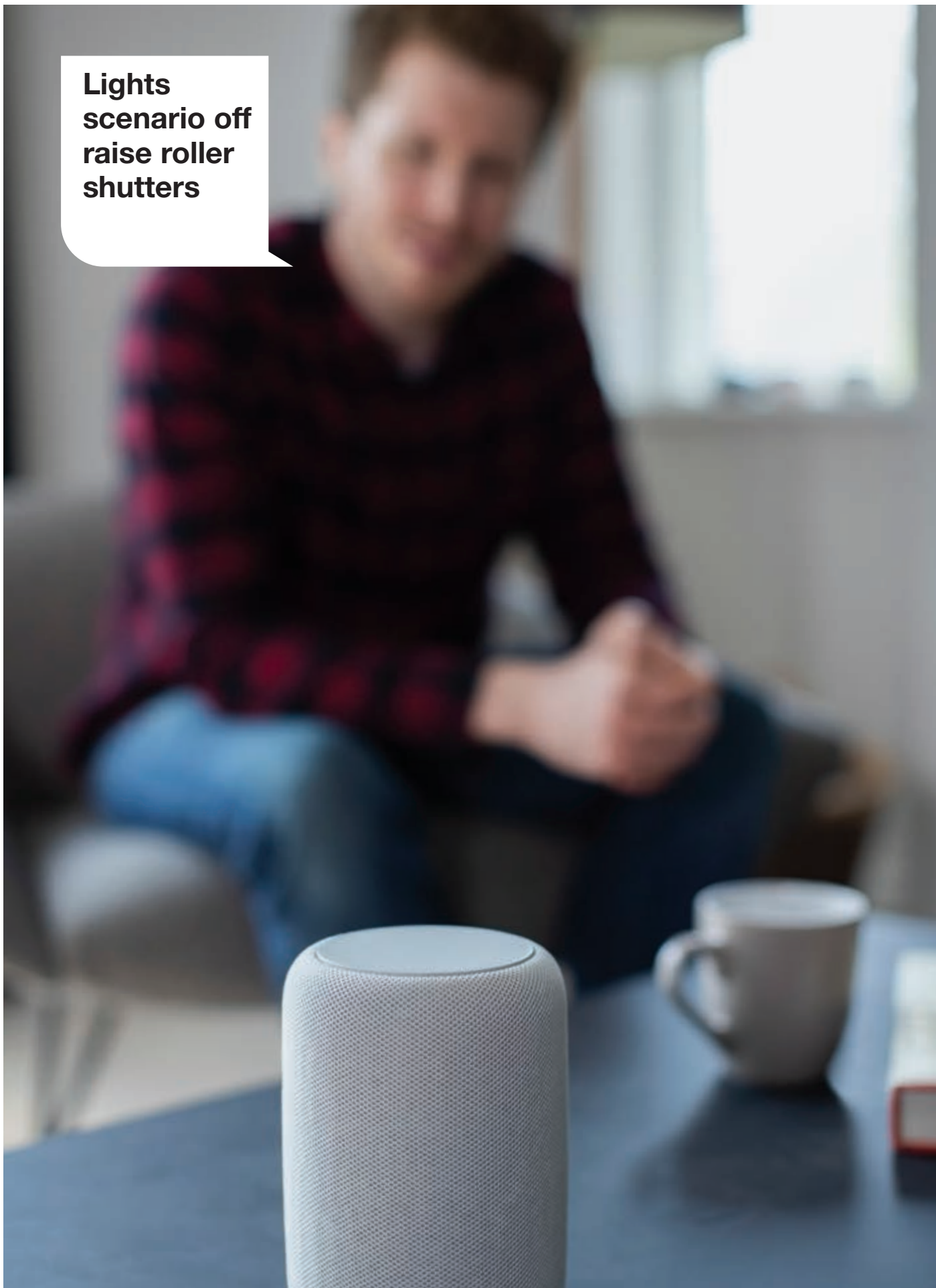

Arké fit is **also smart**



An extensive range of digital solutions to control the building using your smartphone or vocal controls; such as those of the View Wireless devices designed to turn a traditional wiring system into a connected one simply, or the more comprehensive solutions of home automation systems, designed to centralise the functions and offer maximum customisation and system management.

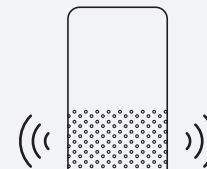

We design spaces together. Unique walls

Made of metal, Arké fit can be teamed with buttons and controls in **anthracite grey, white and Metal**, the new shade featuring a warm metallic effect, to offer an eye-catching total look effect. The traditional painted metal and faced metal finishes have been supplemented with **three new colours for the cover plate: Lipari Sands, Dove Grey and Siena Soil**.

Pastel colours and soft hues, for simple and gentle combinations. A generous **11 different finishes**, capable of accommodating the latest style trends.

Total Look cover plates



Metal



Matt graphite



Matt polar





Pastel cover plates



Lipari Sands

Dove Grey

Siena Soil

Metal-Elite cover plates

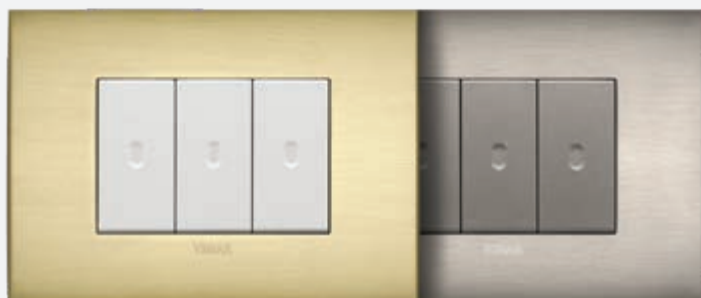

Brushed brass

Brushed steel



Metal-Color cover plates



Silver

Matt slate grey

Matt bronze

Complete solutions to enhance the value of your settings



Basic functions for lights and automation, highly customizable



Centralized and timed basic functions



Programmable functions, managed remotely and with voice

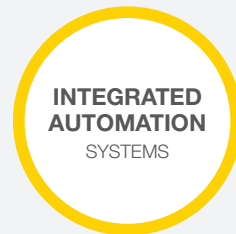

Professional automation integration and scalable functions



TRADITIONAL SYSTEM

With over 200 functions to choose from, affording superior performance levels and with latest-generation intuitive controls, Arké with fit cover plate makes everyday life easier, optimising time and energy consumption.



ADVANCED TRADITIONAL SYSTEM

Traditional system with centralised functions. Thanks to the Quid magnetic relay, which is as silent as an electronic relay, you can centralise the shutting off of lights and automate roller shutters, and also save your favourite position. High-performance solutions for state-of-the-art functionality and comfort.

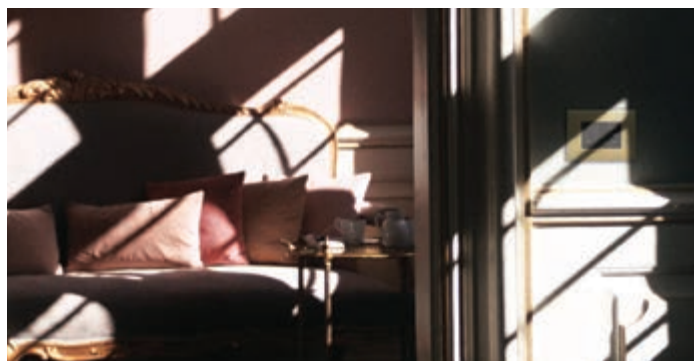



SMART SYSTEM

Individual connected devices. Without any masonry work and in just a few simple steps, you can transform your traditional system into a connected one. Lights, roller shutters and consumption levels can also be controlled using your smartphone or voice assistants. With both Bluetooth and Zigbee technology.

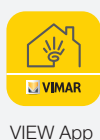

HOME AUTOMATION SYSTEM

A smart, connected system, with complete functions. On both proprietary By-me Plus standard and KNX standard for maximum customisation, centralisation and system management.



Easy solutions to live better



USB SOCKET OUTLETS

The type A connector has now been supplemented with the type C one, the new technological standard used to power and charge latest-generation devices. Ideal in hotel rooms and offices.



QUID MAGNETIC RELAY

As silent as an electronic relay, this device allows you to centralise the shutting off of lights and to automate roller shutters in a traditional system, and also save your favourite position.



INFRARED 1-WAY SWITCH

Without touching the 1-way switches with your hands, the infrared motion sensor 1-way switch turns the lights on and off only when necessary. Or as someone passes or at dusk. Ideal for optimising electricity consumption levels and to avoid contact with the lighting device.



WI-FI ACCESS POINT

The network signal reaches every corner of the house. The ideal solution to extend your Internet connection throughout your home, even to areas that are not reached by the Wi-Fi signal or where the signal is weaker, providing coverage to all rooms.



TOUCH TIMER-THERMOSTAT

For optimum climate control and programmable from smartphone via By-clima app. With RGB backlighting for colour-coordinated controls.

Temperature and humidity probes are also available.



By-clima App



ARKÉ fit

Cover plates



Metal-Elite

(Refined metal)



▲ 12 Brushed brass



▲ 08 Brushed steel

Metal-Color

(Varnished metal)



▲ 03 Silver



▲ 02 Matt slate



▲ 24 Matt bronze

Pastel

(Varnished metal)



▲ 31 Lipari Sands



▲ 32 Dove Grey



▲ 33 Siena Soil

Total Look

(Varnished metal)



▲ 26 Matt polar



▲ 01 Matt graphite



▲ 14 Metal

	3 modules	4 modules	7 modules
Metal-Elite (Refined metal)			
Brushed brass	▲19953.12	▲19954.12	▲19957.12
Brushed steel	▲19953.08	▲19954.08	▲19957.08
Metal-Color (Varnished metal)			
Silver	▲19953.03	▲19954.03	▲19957.03
Matt slate	▲19953.02	▲19954.02	▲19957.02
Matt bronze	▲19953.24	▲19954.24	▲19957.24
Pastel (Varnished metal)			
Lipari Sands	▲19953.31	▲19954.31	▲19957.31
Dove Grey	▲19953.32	▲19954.32	▲19957.32
Siena Soil	▲19953.33	▲19954.33	▲19957.33
Total Look (Varnished metal)			
Matt polar	▲19953.26	▲19954.26	▲19957.26
Matt graphite	▲19953.01	▲19954.01	▲19957.01
Metal	▲19953.14	▲19954.14	▲19957.14

Dimensions

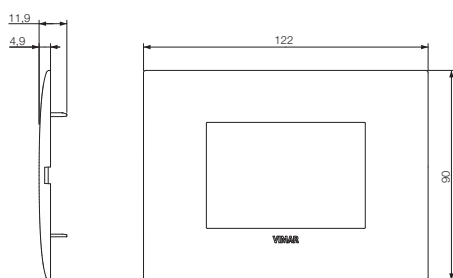

19953... - 3-module cover plate

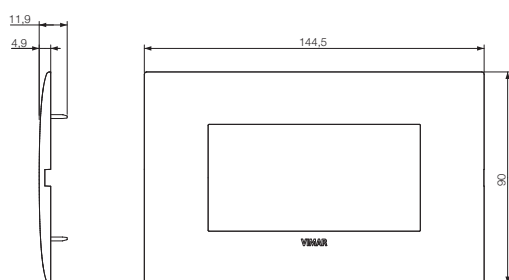



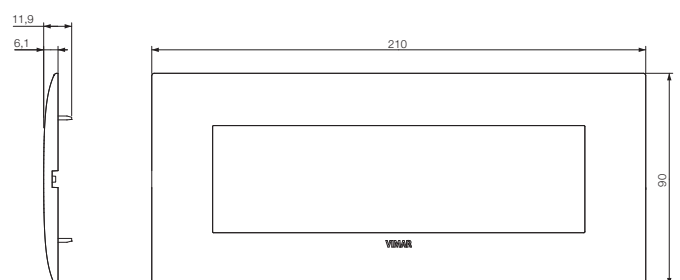









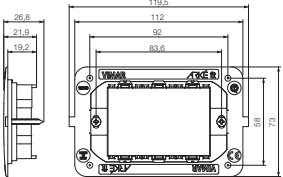



19954... - 4-module cover plate

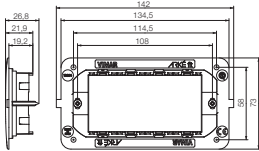

19957... - 7-module cover plate

ARKÉ fit

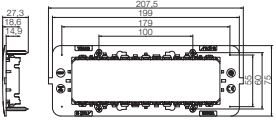
Installation types

Modules	Flush mounting box	Mounting frame	Cover plate	Spacer
3	 <p>V71303 For masonry walls GW 650 °C, light blue V71303.AU GW 960 °C, black</p>  <p>V71703 For hollow walls, GW 850 °C, light blue</p>	 <p>19913 3-module, with screws</p> 	 <p>19953... Fit 3-module Dimensions: 122x90x4.9 mm</p>	 <p>19913.D - grey 19913.D.B - white To be used when installing: 19478, 19446, 19196, 19195, 19135, 19135.1, 19136.1, 19593.</p>
4	 <p>V71304 For masonry walls GW 650 °C, light blue V71304.AU GW 960 °C, black</p>  <p>V71704 For hollow walls, GW 850 °C, light blue</p>	 <p>19914 4-module, with screws</p> 	 <p>19954... Fit 4-module Dimensions: 144.5x90x4.9 mm</p>	 <p>19914.D - grey 19914.D.B - white To be used when installing: 19478, 19446, 19196, 19195, 19135, 19135.1, 19136.1, 19593.</p>
7	 <p>V71306 For masonry walls GW 650 °C, light blue V71306.AU GW 960 °C, black</p>  <p>V71706 For hollow walls, GW 850 °C, light blue</p>	 <p>19917 7-module, with screws</p> 	 <p>19957... Fit 7-module Dimensions: 210x90x6.1 mm</p>	

Choose your Vimar service



A service platform, Vimar's know-how at your fingertips 24/7.

Dedicated documentation, technical and systems engineering information, design services and on-line quoting services.

Go to the section:

- > **training** - choose between classroom or on-line courses, to stay up-to-date at all times even remotely
- > **support and download**: video tutorials, easy access thanks to the wealthy download section for all Vimar documentation
- > **on-line catalogue**: all the details of what Vimar has to offer at all times

VIMAR IS A ONE-STOP SHOP.



B C20036 EN 2007



8 007352 652293



Viale Vicenza, 14
36063 Marostica VI - Italy
Tel. +39 0424 488 600
Fax +39 0424 488 709
www.vimar.com